

**PR**  
electronics



**7908/7916/7932**

**System 9000 Backplane**

No. 7900V100-UK

From ser. no 139425001

**ATEX** 

**IECEx**  

**FM**  
C US  
APPROVED

**UL**  
C US  
LISTED

- DK** ▶ PR electronics A/S tilbyder et bredt program af analoge og digitale signalbehandlingsmoduler til industriel automation. Programmet består af Isolatorer, Displays, Ex-barrierer, Temperaturtransmittere, Universaltransmittere mfl. Vi har modulerne, du kan stole på i selv barske miljøer med elektrisk støj, vibrationer og temperaturudsving, og alle produkter opfylder de strengeste internationale standarder. Vores motto »Signals the Best« er indbegrebet af denne filosofi - og din garanti for kvalitet.
- UK** ▶ PR electronics A/S offers a wide range of analog and digital signal conditioning devices for industrial automation. The product range includes Isolators, Displays, I.S. Interfaces, Temperature Transmitters, and Universal Devices. You can trust our products in the most extreme environments with electrical noise, vibrations and temperature fluctuations, and all products comply with the most exacting international standards. »Signals the Best« is the epitome of our philosophy - and your guarantee for quality.
- FR** ▶ PR electronics A/S offre une large gamme de produits pour le traitement des signaux analogiques et numériques dans tous les domaines industriels. La gamme de produits s'étend des transmetteurs de température aux afficheurs, des isolateurs aux interfaces SI, jusqu'aux modules universels. Vous pouvez compter sur nos produits même dans les conditions d'utilisation sévères, p.ex. bruit électrique, vibrations et fluctuations de température. Tous nos produits sont conformes aux normes internationales les plus strictes. Notre devise »SIGNALS the BEST« c'est notre ligne de conduite - et pour vous l'assurance de la meilleure qualité.
- DE** ▶ PR electronics A/S verfügt über ein breites Produktprogramm an analogen und digitalen Signalverarbeitungsgeräte für die industrielle Automatisierung. Dieses Programm umfasst Displays, Temperaturtransmitter, Ex- und galvanische Signaltrenner, und Universalgeräte. Sie können unsere Geräte auch unter extremen Einsatzbedingungen wie elektrisches Rauschen, Erschütterungen und Temperaturschwingungen vertrauen, und alle Produkte von PR electronics werden in Übereinstimmung mit den strengsten internationalen Normen produziert. »Signals the Best« ist Ihre Garantie für Qualität!

# 7908/7916/7932 SYSTEM 9000 BACKPLANE

## CONTENTS

Warning.....	2
Safety instructions.....	3
Application.....	5
Technical characteristics.....	5
Mounting / installation / programming.....	6
Order codes .....	7
Specifications .....	7
Mounting on DIN rail.....	9
Mechanical dimensions .....	10
7908/7916/7932 installation .....	12
Connections, LED indications, fuses and DIP switches.....	13
CN1 and CN2 connectors .....	13
Replacing the F1 & F2 Fuses .....	13
Block diagram.....	14



**GENERAL**

## **WARNING**

To avoid the risk of electric shock and fire, the safety instructions of this guide must be observed and the guidelines followed. The specifications must not be exceeded, and the device must only be applied as described in the following. Prior to the commissioning of the device, this installation guide must be examined carefully. Only qualified personnel (technicians) should install this device. If the equipment is used in a manner not specified by the manufacturer, the protection provided by the equipment may be impaired. Until the device is fixed, do not connect hazardous voltages to the device. Repair of the device must be done by PR electronics A/S only.



**CAUTION**

## **WARNING**

Potential electrostatic charging hazard. To avoid the risk of explosion due to electrostatic charging of the enclosure, do not handle the units unless the area is known to be safe, or appropriate safety measures are taken to avoid electrostatic discharge.

## **SYMBOL IDENTIFICATION**



**Triangle with an exclamation mark:** Read the manual before installation and commissioning of the device in order to avoid incidents that could lead to personal injury or mechanical damage.



**The CE mark** proves the compliance of the device with the essential requirements of the directives.



**Ex devices** have been approved according to the ATEX directive for use in connection with installations in explosive areas.

# SAFETY INSTRUCTIONS

## RECEIPT AND UNPACKING

Unpack the device without damaging it. The packing should always follow the device until this has been permanently mounted. Check at the receipt of the device whether the type corresponds to the one ordered.

## ENVIRONMENT

void direct sunlight, dust, high temperatures, mechanical vibrations and shock, as well as rain and heavy moisture. If necessary, heating in excess of the stated limits for ambient temperatures should be avoided by way of ventilation. All devices can be used for Overvoltage Category II and Pollution Degree 2. The modules are designed to be safe at least under an altitude up to 2 000 m.

## MOUNTING

Mounting and connection of the device should comply with national legislation for mounting of electric materials, i.e. wire cross section, protective fuse, and location.

Descriptions of input / output and supply connections are shown in this installation guide and on the side label. The device is provided with field wiring terminals and shall be supplied from a Power Supply having double / reinforced insulation. A power switch should be easily accessible and close to the device. The power switch shall be marked as the disconnecting unit for the device.

The 7908/7916/7932 Backplane can be mounted on a 35 x 15 mm DIN rail according to EN 60715.

## CALIBRATION AND ADJUSTMENT

During calibration and adjustment, the measuring and connection of external voltages must be carried out according to the specifications of this installation guide. The technician must use tools and instruments that are safe to use.

## CLEANING

When disconnected, the device may be cleaned with a cloth moistened with distilled water.

## **UL INSTALLATION (PENDING APPROVAL)**

Use 60/75°C copper conductors only.

Wire size ..... AWG 26-12

UL file number ..... E231911

The device is an Open Type Listed Process Control Equipment. To prevent injury resulting from accessibility to live parts the equipment must be installed in an enclosure. The power Supply unit must comply with NEC Class 2, as described by the National Electrical Code® (ANSI / NFPA 70).

## **cFMus INSTALLATION IN DIVISION 2 OR ZONE 2 (PENDING APPROVAL)**

Class I, Div. 2, Group A, B, C, D T4 or I, Zone 2, AEx nA IIC T4 or Ex nA IIC T4.

In class I, Division 2 or Zone 2 installations, the subject equipment shall be mounted within a tool-secured enclosure which is capable of accepting one or more of Class I, Division 2 wiring methods specified in the National Electrical Code (ANSI/ NFPA 70) or in Canada in the Canadian Electrical Code (C22.1).

The 7908/7916/7932 Backplane must be connected to limited output NEC Class 2 circuits, as outlined in the National Electrical Code® (ANSI / NFPA 70), only. If the devices are connected to a redundant power supply (two separate power supplies), both must meet this requirement.

Where installed in outdoor or potentially wet locations the enclosure shall at a minimum meet the requirements of IP54.

Warning: Substitution of components may impair suitability for zone 2 / division 2.

Warning: To prevent ignition of the explosive atmospheres, disconnect power before servicing and do not separate connectors when energised and an explosive gas mixture is present.

Warning: Do not mount or remove devices from the backplane when an explosive gas mixture is present.

## **IECEX, ATEX INSTALLATION IN ZONE 2**

IECEX, Ex nA IIC T4 Gc..... DEK 13.0044X

ATEX, II 3 G Ex nA IIC T4 Gc ..... DEKRA 13ATEX0136X

For safe installation the following must be observed. The device shall only be installed by qualified personnel who are familiar with the national and international laws, directives and standards that apply to this area.

Year of manufacture can be taken from the first two digits in the serial number.

The device shall be installed in a suitable enclosure providing a degree of protection of at least IP54 according to EN60529, taking into account the environmental conditions under which the equipment will be used.

To prevent ignition of the explosive atmospheres, disconnect power before servicing and do not separate connectors when energised and an explosive gas mixture is present. Do not mount or remove devices from the backplane when an explosive gas mixture is present.

## 7908/7916/7932 SYSTEM 9000 BACKPLANE

- *Provides safe, easy wiring between the backplane and non I.S. automation systems using standard prefabricated I/O cables*
- *Uses PR system 9000 units to make AI, AO, DI and DO process signals intrinsically safe*
- *Direct, Redundant and Duplicate signalling - including HART I/O*
- *Robust, compact high-end design solution that holds 8, 16 or 32 system 9000 units*
- *Digital Output and LEDs indicate backplane system status*

### **Application**

- The 7908/7916/7932 backplane is a compact and robust solution that enables a safe and easy connection of PR system 9000 IS device signals into standard automation systems.
- Standard automation system cables and connectors are used to link the backplane to the I/O cards.
- The 7908/7916/7932 backplane can be used for Direct, Redundant, Duplicate signalling including HART I/O System connectivity (HART MUX).
- The system 9000 devices isolate and convert AI, AO, DI and DO signals coming from, or going to the I.S. classified area, and routes those signals to a system automation I/O card.
- The system 9000 units maintain a SIL2 level of functional safety, even when mounted in the backplane solution.

### **Technical characteristics**

- Robust, compact high-end design that holds 8, 16 or 32 system 9000 units.
- Digital output indicates status of the 9000 devices and primary/back-up power supplies.
- Flexible 24 VDC supply voltage and redundant power supply connection solution.

## **Mounting / installation / programming**

- Flexible horizontal/vertical panel or wall mounting in the Safe or Zone 2 / Div. 2 areas.
- System 9000 devices easily snap ON and OFF using piano keys, and devices can be hot swapped if mounting is in safe area.
- Tag number and ID labels are easily mounted and read by using the dedicated piano key spacer.
- Wide temperature operation range: -20...+60°C.



## Order codes

Type	Specification	Supported DCS systems and I/O cards
7908	8 module backplane	Check separate selection guide for supported DCS systems and I/O cards.  A wiring list is available on the individual supported DCS system I/O cards.
7916	16 module backplane	
7932	32 module backplane	

## Specifications

### Environmental conditions:

Specifications range .....	-20°C to +60°C
Storage temperature .....	-40°C to +85°C
Relative humidity.....	< 95% RH (non-cond.)
Installation in pollution degree 2 / overvoltage category II.	

### Mechanical specifications:

Dimensions (HxWxD), 7908.....	144 x 247 x 141 mm
Dimensions (HxWxD), 7916.....	144 x 443 x 141 mm
Dimensions (HxWxD), 7932.....	144 x 835 x 141 mm
Weight approx., (7908/7916/7932).....	1050 / 1850 / 3350 g
Wire gauge, max .....	2.5 mm <sup>2</sup> / AWG 12
(Supply 1 / 2 and status relay connectors)	
Mounting.....	35 x 15 mm DIN rail (EN 60715), Panel plate or Wall mounting

### Common electrical specifications:

Supply voltage, 24 DC nom. .... 20...31.2 VDC

Power consumption, 7908 - 8 unit bp..... ≤ 30 W  
(Fuse F 1 & F 2: 1.6 A SB, 250 V, Type TR5)

Power consumption, 7916 - 16 unit bp..... ≤ 60 W  
(Fuse F 1 & F 2: 3.15 A SB, 250 V, Type TR5)

Power consumption, 7932 - 32 unit bp..... ≤ 120 W  
(Fuse F 1 & F 2: 6.3 A SB, 250 V, Type TR5)

Isolation voltage - test / working ..... 500 VAC / 50 VAC  
(Basic isolation between supply 1 & 2 and status relay)

## Status relay output terminal 1 and 2:

Max. voltage and current,

Zone 2 / Div. 2 area ..... 32 V / 100 mA

Max. voltage and current, Safe area..... 42 V / 100 mA

## Approvals:

EMC 2004/108/EC ..... EN 61326-1

c UL us, , Standard for Safety ..... UL 508

CE, Standard for Safety ..... EN 61010-1

## Ex:

ATEX, II 3 G Ex nA IIC T4 Gc ..... DEKRA 13ATEX0136X

IECEX, Ex nA IIC T4 Gc ..... DEK 13.0044X

c FM us, Zone 2 / Div 2 ..... xxxx-C (pending)

## 7908 Backplane - 8 module setup

Connectors have built-in test probe access for easy HART® programming



## MOUNTING ON DIN RAIL

The backplane can easily be mounted on a standard 35 mm DIN rail:  
A 15 mm high DIN rail type must be used.

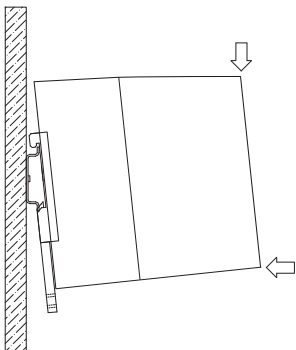

Remove the backplane from the rail by lifting the DIN rail mounting clips:

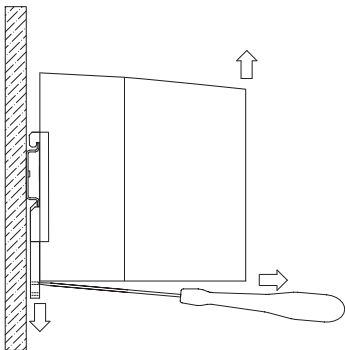

To allow for easy product change the DIN rail mounting clips can be set in the down/release position.

# MECHANICAL DIMENSIONS

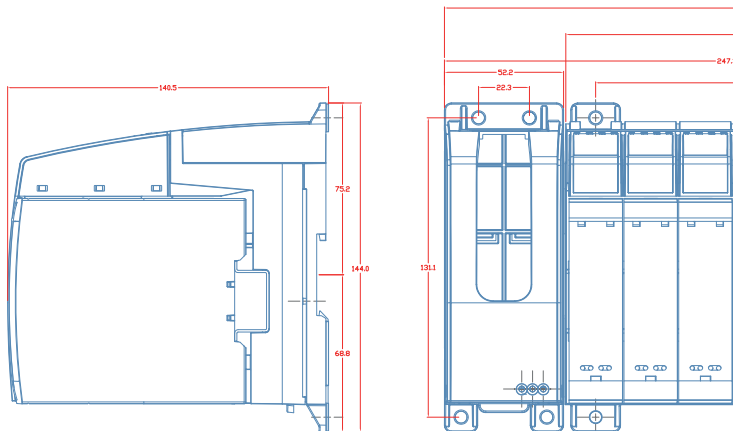

# MECHANICAL DIMENSIONS

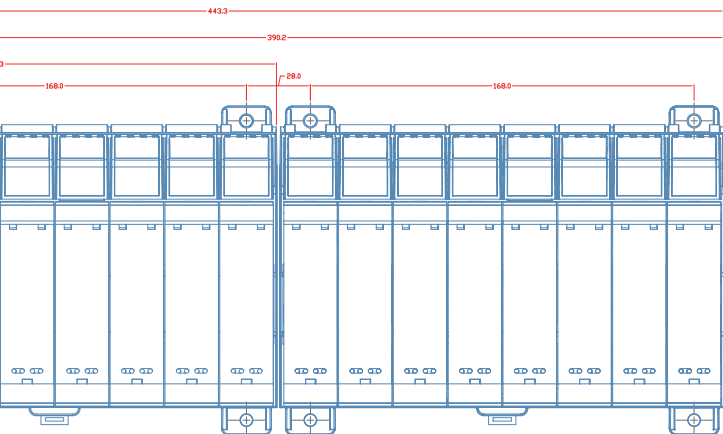

# 7908/7916/7932 INSTALLATION

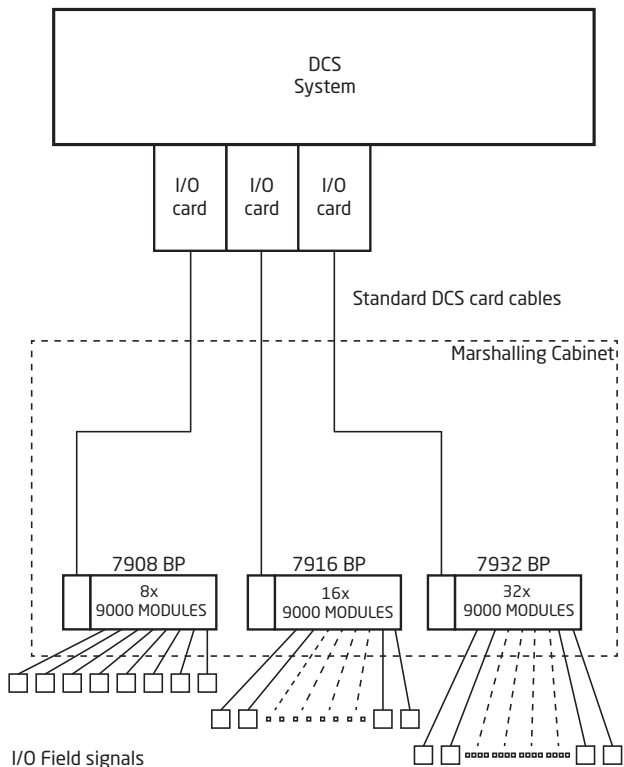

## Connections, LED indications, fuses and DIP switches

DIP SW.	Function
1	ON = Ignore Power Supply 2 error
2	ON = Enable module Status signal

LED 1	Green : Power Supply 1 OK Off : Power Supply 1 Error
LED 2	Green : Power Supply 2 OK Off : Power Supply 2 Error
LED 3	Off : Status signal OK Red : Status signal Error

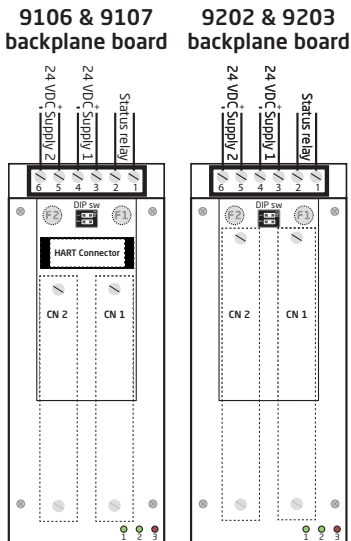

### CN1 and CN2 connectors

provides Direct, Redundant and Duplicate, including HART signal connection wiring, between the Backplane and the DCS system. This by using standard automation system cables.

### Replacing the F1 & F2 Fuses

1. Remove power from the Backplane and open the connector module cover. Remove the 4 holding screws located on each PCB corner.
2. Pull out the adaptor board by using the mounted DCS cable or a plier tool and locate the F1 and F2 fuses mounted in sockets.
3. Insert a new fuse to same type. Check page 7 for specific fuse type.
4. Remount all mechanical parts and repower the Backplane system.

# BLOCK DIAGRAM

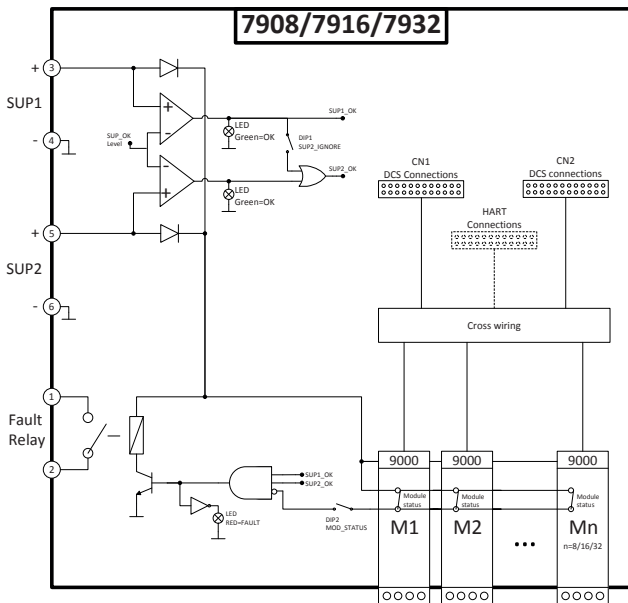

DIP sw.	Function
1	ON = Ignore Power Supply 2 Error
2	ON = Enable Module Status Signal

LED 1	Green = OK Power Supply 1 Off = Error Power Supply 1
LED 2	Green = OK Power Supply 2 Off = Error Power Supply 2
LED 3	Off = Status signal OK Red = Status signal Error

Fault Relay status terminal 1 & 2	Condition	Action required
Contact Closed	OK	-
Contact Open	Error	Check DCS Supply 1 or 2 condition or an individual Module Status Error Signal is activated





**Displays** Programmable displays with a wide selection of inputs and outputs for display of temperature, volume and weight, etc. Feature linearization, scaling, and difference measurement functions for programming via PReset software.



**Ex interfaces** Interfaces for analog and digital signals as well as HART® signals between sensors / I/P converters / frequency signals and control systems in Ex zone 0, 1 & 2 and for some devices in zone 20, 21 & 22.



**Isolation** Galvanic isolators for analog and digital signals as well as HART® signals. A wide product range with both loop-powered and universal isolators featuring linearization, inversion, and scaling of output signals.



























**Temperature** A wide selection of transmitters for DIN form B mounting and DIN rail devices with analog and digital bus communication ranging from application-specific to universal transmitters.



**Universal** PC or front programmable devices with universal options for input, output and supply. This range offers a number of advanced features such as process calibration, linearization and auto-diagnosis.



- 
 [www.preelectronics.fr](http://www.preelectronics.fr)  
 [sales-fr@preelectronics.com](mailto:sales-fr@preelectronics.com)
- 
 [www.preelectronics.de](http://www.preelectronics.de)  
 [sales-de@preelectronics.com](mailto:sales-de@preelectronics.com)
- 
 [www.preelectronics.es](http://www.preelectronics.es)  
 [sales-es@preelectronics.com](mailto:sales-es@preelectronics.com)
- 
 [www.preelectronics.it](http://www.preelectronics.it)  
 [sales-it@preelectronics.com](mailto:sales-it@preelectronics.com)
- 
 [www.preelectronics.se](http://www.preelectronics.se)  
 [sales-se@preelectronics.com](mailto:sales-se@preelectronics.com)
- 
 [www.preelectronics.co.uk](http://www.preelectronics.co.uk)  
 [sales-uk@preelectronics.com](mailto:sales-uk@preelectronics.com)
- 
 [www.preelectronics.com](http://www.preelectronics.com)  
 [sales-us@preelectronics.com](mailto:sales-us@preelectronics.com)
- 
 [www.preelectronics.cn](http://www.preelectronics.cn)  
 [sales-cn@preelectronics.com](mailto:sales-cn@preelectronics.com)

## Head office

Denmark  
 PR electronics A/S  
 Lerbakken 10  
 DK-8410 Rønde

[www.preelectronics.com](http://www.preelectronics.com)  
[sales-dk@preelectronics.com](mailto:sales-dk@preelectronics.com)  
 tel. +45 86 37 26 77  
 fax +45 86 37 30 85



QUALITY SYSTEM AND ENVIRONMENTAL MANAGEMENT SYSTEM  
 DS/EN ISO 9001  
 DS/EN ISO 14001

